

# Data Sheet



Article number: 20490288AMT

Description: E+G Clamp mounting - GN 490-28-8-A-MT

## Measures

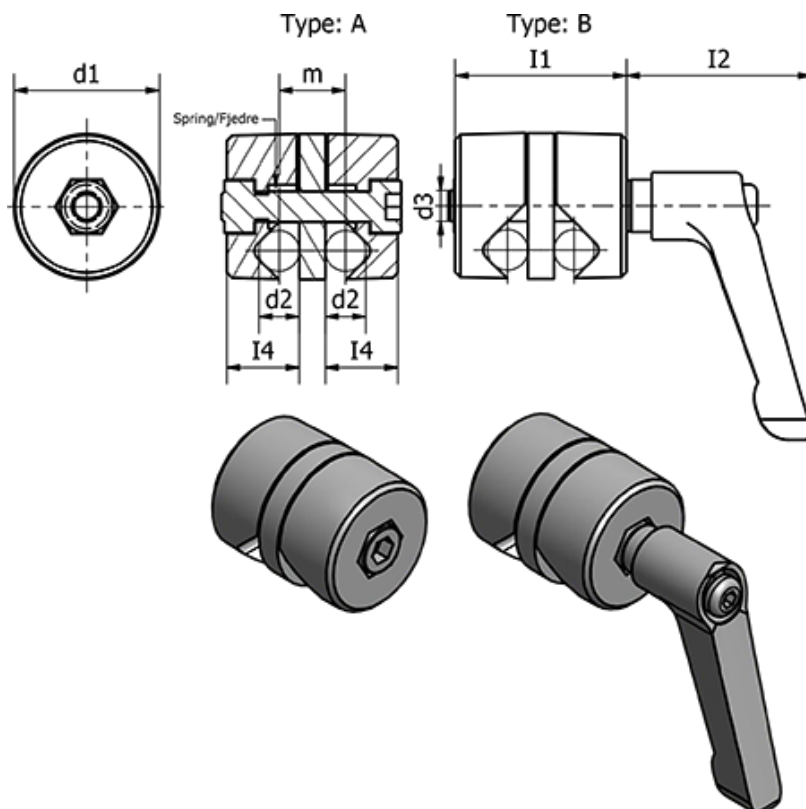

$d1 = 28$	$m = 13$
$d2 = 8$	Weight (g) = 52
$d3 = M6$	
$I1 = 33$	
$I2 = -$	
$I3 = -$	
$I4 = 14$	
$I5 = 5$	